

Experience the Variety of Applications

Roller Chains with Attachments

- ***Standard Attachments***
- ***Special Attachments
for Individual
Challenges***
- ***Quick Step***

Rexnord Quality Chains - Experience the variety of applications

Rexnord has been manufacturing chains in many different designs since 1892. The experience gained in many decades, as well as continuous research, ensure the development of products of advanced design with a high degree of dependability. A large number of patents confirm the extraordinary innovative spirit that has become an essential part of this company. Rexnord's quality chains are now being applied to many different uses, serve various functions and meet versatile needs. The use of more than a thousand self-developed tools in the manufacturing process satisfies this variety of possible applications. More than 650 special tools have been constructed for producing special chains. Thirty special steels, which are alloyed, rust-resistant and patented, are processed. Furthermore, Rexnord offers a multitude of high quality lubricants. The engineers offering technical application advice take into consideration the interests of individual clients when calculating and identifying the correct chain drives, and therefore provide the highest level of service. These basic requirements guarantee the optimal fulfillment of all customer demands with the highest grade of service and the highest-quality products.



Thinking and acting like partners



Consulting service, the ability to work as partners and the experience of our sales team help to drive a high level of customer satisfaction. The technical Rexnord application consulting service listens attentively to customers and does analysis immediately in order to develop a practical solution. Rexnord observes the field of drives and conveying worldwide and by doing so, acquires extensive, on-going market knowledge and technological competence. This knowledge of course not only ensures competitiveness, but it also brings about substantial benefits for customers.

Table of Contents

Introduction.....	1 - 5
Quick Step.....	6
Overview connecting links.....	7
Standard Attachments:	
M-Attachment, one bore hole.....	8 - 9
M-Attachment, two bore holes.....	10
Straight connecting links.....	11
K-Attachment, one bore hole	12 - 13
K-Attachment, two bore holes.....	14
Extended Pins.....	15 - 16
The Chain-Clip-System.....	17
Pin Oven Chains.....	18 - 19
Examples of various uses in timber industry.....	20 - 21
Examples of various uses in the food industry.....	22 - 23
Examples of various uses in the packaging industry.....	24 - 25
Other special attachments.....	26 - 31

Rexnord - Precision. Power. Performance.

Quality – Prerequisite for Maximum Operational Safety



Rexnord Kette is DIN ISO 14001 and 9001 certified because of its quality management system. Roller chains belong to the group of products that are governed by DIN standards.

The quality of a chain is not determined by the tensile strength factor, but by the amount of fatigue and wear resistance. As a result, despite standardization, roller chains with the same tensile strength from different producers will not always be the same in quality.

The chains that Rexnord has developed and used in the production process make possible an optimal combination of defined quality factors. The hardening of the chain elements, which are made from selected high performance steel, contributes fundamentally to the extension of the life time of the chain. Ball-drifting of the plate bores and intensive shot peening of all chain elements, as well as the utilization of seamless rollers, results in a significant improvement in fatigue strength. High pre-loading of the chains and a secure production process, which is ensured by receiving inspection, final inspection and regular tests throughout production, help contribute to a maximal reliability of the chain.

Rexnord – Quality Criteria

Tensile Strength

The stated level of ultimate tensile strength is of little significance, because just before reaching the breaking point – above the limit of elasticity – the chain will become permanently deformed, rendering it unusable.

Limit of Elasticity

The limit of elasticity sets the upper limit under which there is no permanent plastic deformation which would render the chain unusable. Below this limit, loads and operational shocks cause elongation which only lasts as long as the loading effect.

Fatigue Strength

The fatigue strength boundary is defined as the value of the repeated operational and pulsating loads, imposed by the sprocket polygon effect or changing loads, that the chain can withstand without suffering failure from metal fatigue. In order to achieve high fatigue strength, other than through production engineering and the supply of quality material, tensile strength plays an important role. When the breaking force is too high, this can be seen as a disadvantage because it is related to a reduction in the toughness and fatigue strength values. If the tensile strength of a chain is increased above a certain value, then the decisive value of the fatigue strength is reduced considerably.

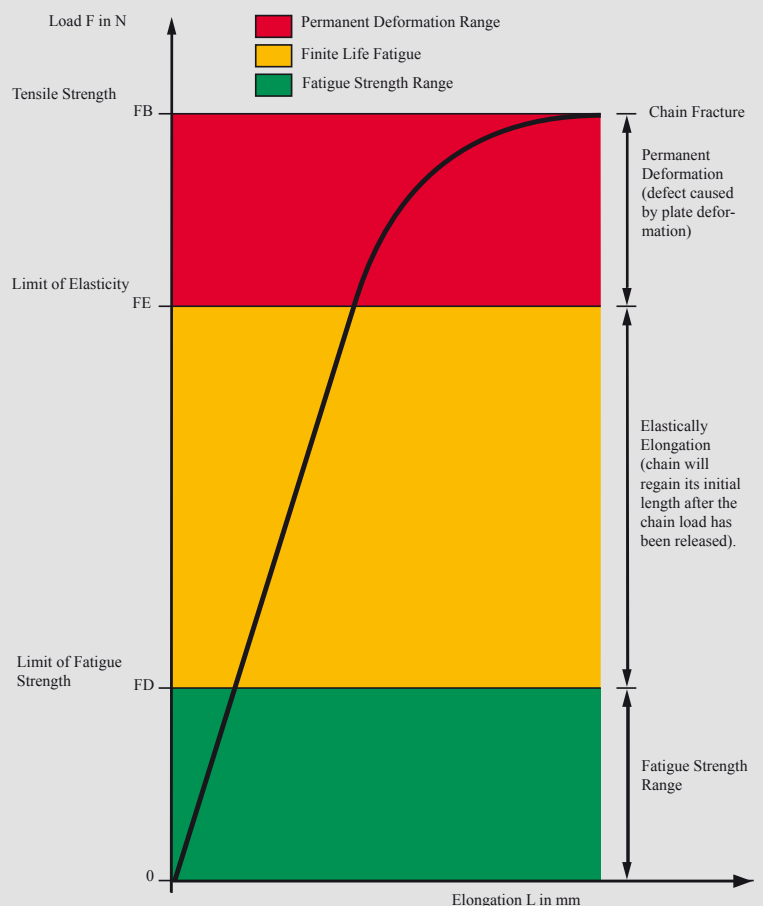

Roller Chains with Attachments – An Integral Part of Modern Dynamics

You want to move objects, transport articles, lift or correctly position something? Rexnord roller chains with attachments offer you a wide spectrum of possibilities for an optimal and functional design of your equipment or drive trains. The following pages contain a variety of possibilities for solutions and can give you one or more suggestions about how you can use the products from Rexnord for your purposes.

Every attachments can be used as outer plates for RexCarbon and sidebow chains. Attachments as inner plates can be used for RexCarbon and sidebow chains on request.

Consultancy is our strength

Whenever you ask questions, we are able to correctly answer them. At your request, our application advisor will also develop special solutions. You can use the know-how from Rexnord for all your special application needs. We are happy to work with you and help you in any way we can.



Rexnord Quick-Step: A Service Programme for Attachment Chains

Do you have a problem and need spare parts or attachments? The service system "Rexnord Quick Step" is prompt, safe and dependable. Especially advantageous for you: your request will be prepared immediately. You can rely on this!

Complete service for Europe

*All you need to do is call: Tell our customer service staff what you need and your chain will be despatched within 48 hours *.*

100 % reliable

If we do not despatch your chain within the stated time it will be supplied free-of-charge.

You can count on "Quick-Step" for the following advantages:

- ▶ saving time and reducing costs**
- ▶ rapid, uncomplicated processing of your order**
- ▶ punctual and safe delivery**
- ▶ service coverage all over Europe**



A call is enough

If you have any questions relating to "Quick-Step", then call our service hotline in

UK: +44 1527 830 473
Denmark: +45 4546 9700
Italy: +39 02 269 9271
Headquarter: +49 2741 284-0.

The Rexnord customer advisors are available from 09.00 to 17.00 every work day. Let us advise you!

Products that are not ordered on a regular basis will not be kept in stock. Therefore, this service is only valid for those products that are frequently required. In order to make the search process easier for you, all applicable Quick Step products are highlighted in pink!!!

** This is only valid for chain orders up to 50 m and does not apply to roller chains with extended pins. These can be despatched within 72 hours.*

The Three Steps for Choosing the Best Solution for your Application

You know Rexnord as your dependable partner for all your chain solutions. We place great value on completeness and have therefore divided up the presentation of our goods into three sections.

1. Which function should my chain fulfill and which attachment should I use?

To start with, we recommend the most frequently used attachments, such as M-attachments, K-attachments or extended pins.

Next, the application examples from three different industries which use typical attachments will be presented into order to clarify the variety of applications of chains. They should give you suggestions for a solution and implementation which meets your special requirements. Furthermore, other special attachments are listed.

2. Which roller chain type can best fulfill this function?

The right choice of the roller chain model predominantly determines the functioning quality of your application. For this reason, we have arranged all types of attachments according to their sizes and classified them in structured tables according to their roller chain type.

In the tabulation summary you can check if the desired attachment is deliverable in the stated size for the roller chain used for your application. If this is not the case, the engineers and technicians will find a solution to meet your specifications.

3. Technical information in only a moment

In the tabulation summary, you will find the measurements of our available attachments, sorted by chain size and chain type. The associated size table and technical drawings are uniformly shaped so that you can work effectively with our catalog and quickly find the correct solution for your application.

Connecting Links

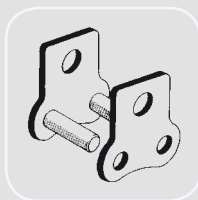

A
outer plate

Pin link A is available for all chains. It can be used as a connecting link or for the production of endless chains. The cover plate exhibits a tight fit. The connecting link can be supplied as an attachment for one or for both sides.

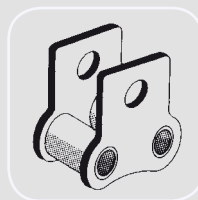

B
inner plate

Pin link B is also available for all chains. If a chain needs to be lengthened or is in need of a repair, the piece can be inserted with two connecting links or two pin links without any problems. The attachments can be mounted on one or on both sides as requested.

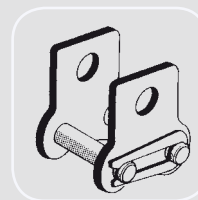

E
connecting link with
spring clip

The connecting link with spring clip is only for chains up to 25,4 mm pitch. In this case, security is achieved by a steel spring that must be mounted so that its opening is applied to the machine direction. The connecting link with spring clip can be mounted on one side or both sides of the attachment at your request.

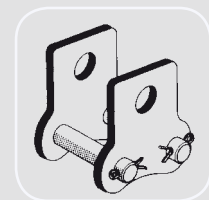

S (G)
connecting link
double cotter

This connecting link double cotter is appropriate for chains larger than 25,4 mm in pitch and is fabricated from a particularly tough steel. For chains according to DIN 8188 standards (ANSI) and for double pitch roller chains, there is a specially formed closure made of a spring wire. Assembly of the attachment parts can be done on one or on both sides depending on your request.

Roller Chains with M-Attachments One Bore Hole

Mounted on one and on both sides

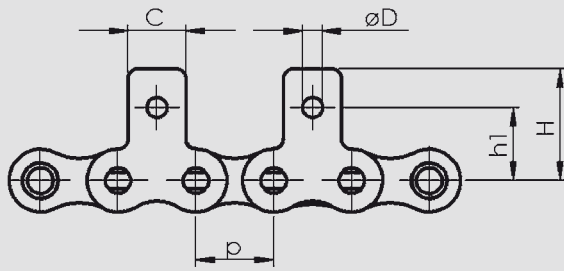
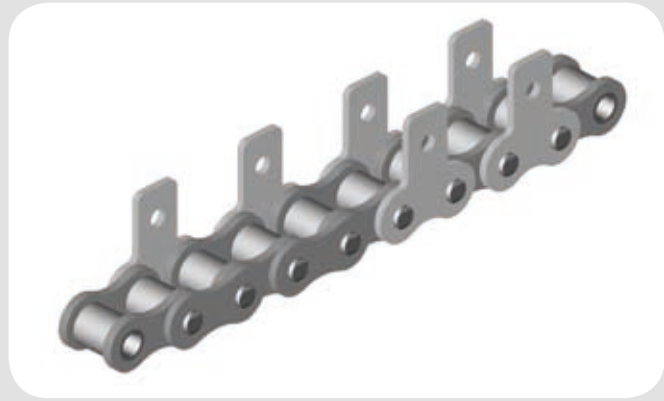

Type 1

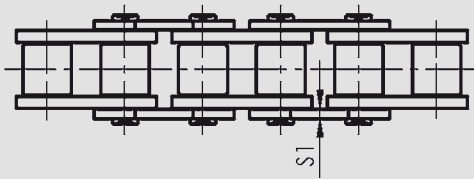

Type of Attachment	Chain description	Name of attachment		Pitch		A	B	C	D	F	G	H	h ₁	h ₂	s ₁	s ₂
		outer	inner	mm	inch	Distance from fixing hole to middle of chain	Width to the middle of chain	Width of the attachment	Diameter of fixing hole	Length of attachment protrusion	Space between the holes	Height of the attachment	Height of fixing hole, exterior	Height of fixing hole, interior	Thickness of material, outer	Thickness of material, inner
Single and Multiple Roller chains, European Standard DIN 8187, American Standard DIN 8188																
1	08 B-1	M 260	M 263	12,7	½ "			10,6	4,3			19	12,7	14,5	1,6	1,6
1	08 B-1	M 260	M 269	12,7	½ "			10,6	4,3			19	12,7	12,7	1,6	1,6
1	08 B-1	M 266	M 265	12,7	½ "			10,6	4,3			19	13,5	13,5	1,6	1,6
1	08 B-1	M 270		12,7	½ "			10,6	5,4			19	12,7		1,6	
1	10 B-1	M 302	M 305	15,875	⅝ "			12,5	5,4			23,4	15,3	17	1,6	1,6
1	10 B-1	M 304		15,875	⅝ "			12,5	5,1			23,4	15,9		1,6	
1	12 B-1	M 400	M 409	19,05	¾ "			16	5,4			28	17,7	17,7	1,8	1,8
1	12 B-1	M 402		19,05	¾ "			16	6,6			28	18,3		1,8	
1	12 B-1	M 488		19,05	¾ "			16	7,2			28	22,2		1,8	
1	16 B-1	M 500	M 503	25,4	1 "			19	6,6			34,2	23,8	26,15	3	3,9
1	20 B-1	M 611		31,75	1 ¼ "			24	10,5			45,3	30,5		3,5	
1	08 A-1	M 222	M 223	12,7	½ "			10,6	3,5			19	12,7	14,4	1,5	1,5
1	10 A-1	M 322	M 321	15,875	⅝ "			12,5	5,4			23,4	15,3	17,5	2	2
1	12 A-1	M 422	M 425	19,05	¾ "			16	5,4			26,2	17,25	20,5	2,4	2,4
1	16 A-1	M 522		25,4	1 "			20	6,65			34,2	23,7		3	

Further designs on request!

Roller Chains with M-Attachments One Bore Hole

Mounted on one and on both sides

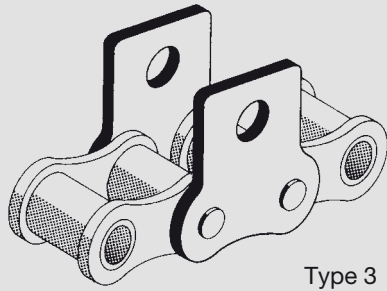

Type 3

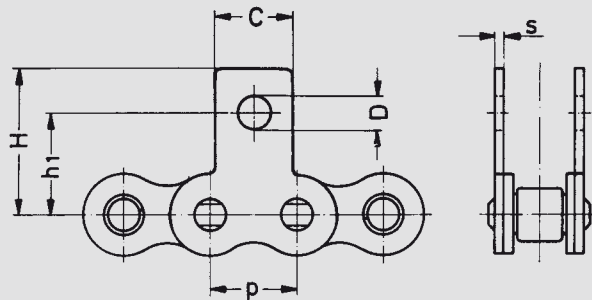

Type of Attachment	Chain description	Name of attachment		Pitch		A	B	C	D	F	G	H	h ₁	h ₂	s ₁	s ₂
		outer	inner	mm	inch	Distance from fixing hole to middle of chain	Width to the middle of chain	Width of the attachment	Diameter of fixing hole	Length of attachment protrusion	Space between the holes	Height of the attachment	Height of fixing hole, exterior	Height of fixing hole, interior	Thickness of material, outer	Thickness of material, inner
Stainless Steel Single and Multiple Roller chains (RexPlus), European Standard DIN 8187, American Standard DIN 8188																
1	08 B-1 SS	M 280		12,7	½ "			10,6	4,3			19	12,7		1,6	
1	10 B-1 SS	M 300		15,875	⅝ "			12,5	5,4			23,4	15,3		1,6	
1	12 B-1 SS	M 490		19,05	¾ "			16	5,4			28	17,7		1,8	
1	16 B-1 SS	M 524		25,4	1 "			19	6,6			34,2	23,7		3,1	
1	10 A-1 SS	M 380		15,875	⅝ "			12,5	5,4			23,4	15,3		2	
Double Pitch Roller Chains, ISO 1275 / DIN 8181																
1	208 B	M 540*		25,4	1 "			20	4,3			20,4	14,3		1,6	
1	210 B	M 632*		31,75	1 ¼ "			25	5,4			28,4	16,1		2	
1	212 B	M 650*		38,1	1 ½ "			31,8	6,6			37,5	24		1,8	
1	216 B	M 830		50,8	2 "			39,8	8,5			39,8	27		3	
1	208 A ^x	M 550*		25,4	1 "			20	5,4			20,4	11,2		1,6	
1	210 A ^{xx}	M 632*		31,75	1 ¼ "			25	5,4			28,4	16,1		2	
Single and Multiple Roller chains, European Standard DIN 8187, American Standard DIN 8188																
3	08 B-1	M 274		12,7	½ "			17,9	7,2			19	13		1,6	
3	16 B-1	M 510		25,4	1 "			36	8,3			36,3	24,3		3	

* Attachment with straight plate

^x Also for chain type C 2040 and C 2042

^{xx} Also for chain type C 2050 and C 2052

Order example:

Roller chain 16B-1 with M-attachments on outer link plates (M 500), on one side (1), every 4 pitches (4p) = 16 B-1 / M 500 – 1/4 p.

Further designs on request!

Roller Chains with M-Attachments Two Bore Holes

Mounted on one and both sides

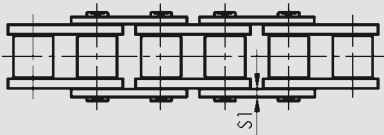
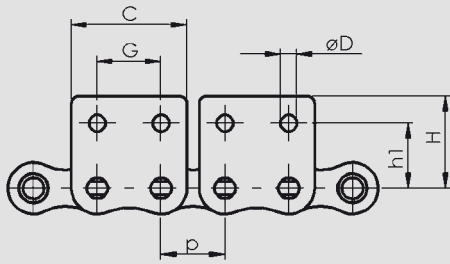

Type 2

Type of Attachment	Chain description	Name of attachment		Pitch		A	B	C	D	F	G	H	h1	h2	s1	s2
		outer	inner	mm	inch	Distance from fixing hole to middle of chain	Width to the middle of chain	Width of the attachment	Diameter of fixing hole	Length of attachment protrusion	Space between the holes	Height of the attachment	Height of fixing hole, exterior	Height of fixing hole, interior	Thickness of material, outer	Thickness of material, inner
Single and Multiple Roller chains, European Standard DIN 8187, American Standard DIN 8188																
2	08 B-1	M 61		12,7	½ "			23,7	4,36		12,55	17,2	12,3		1,6	
2	08 B-1	M 51305		12,7	½ "			24,4	5,03		12,7	19	14,3		1,6	
2	08 B-1	M 188	M 189	12,7	½ "			24,4	4,3		12,7	19	14,3	14,3	1,6	1,6
2	10 B-1	M 346		15,875	⅝ "			28,6	5,1		15,8	21	15,4		1,6	
2	12 B-1	M 452		19,05	¾ "			35,2	6,6		19,05	29,8	20		1,8	
2	12 B-1	M 3695		19,05	¾ "			35,2	6,6		19,05	32	21,5		3,75	
2	12 B-1	M 434*		19,05	¾ "			35	6,6		16	30,2	23		1,8	
2	16 B-1		M 517*	25,4	1 "			45,8	8,3		20	36,8		26,5		4
2	16 B-1	M 572*		25,4	1 "			45,8	8,3		25	36,9	25,9		3	
2	16 B-1	M 576		25,4	1 "			46	8,3		25,4	36,7	25,9		3	
2	20 B-1	M 620		31,75	1 ¼ "			47	8,3		30	42,2	30		4	
2	24 B-1	M 740		38,1	1 ½ "			71,1	10,5		38,1	64,8	47,3		5	
2	24 B-1	M 115903		38,1	1 ½ "			54	9,0		35	52,3	36,5		5	
2	32 B-1	M 92364		50,8	2 "			92,4	12,5		50,5	73,6	52,9			6,3
Stainless Steel Single and Multiple Roller chains (RexPlus), European Standard DIN 8187, American Standard DIN 8188																
2	08 B-1 SS	M 294		12,7	½ "			24,4	4,3		12,7	19	14,3		1,6	
2	12 B-1 SS	M 494		19,05	¾ "			35,2	6,6		19	27,7	18,6		1,8	

* Attachment with straight plate.

Further designs on request!

Roller Chains with Straight Connecting Links as Attachments

Chains can easily be equipped with special attachments by means of straight connecting links. There are a range of possible combinations. For example, single strand chains can be equipped with straight duplex or triplex connecting links. Double chains can be equipped with triplex connecting links.

As shown in Figures I – V, a symmetric and an asymmetric combination are both possible.

For example, if a combination of two single strand roller chains with several triplex connecting links (shown in Figure 5) is necessary, the chains must be matched

as a pair. Large pitch roller chains can be combined in the same way.

Rexnord will gladly offer you technical suggestions and price quotations at your request.

Roller Chain-Connecting Link Combination

I, II = Single strand chain with double connecting link

IV = Double strand chain with triple connecting link

III = Single strand chain with triple connecting link

V = 2 x Single strand chain with triple connecting link

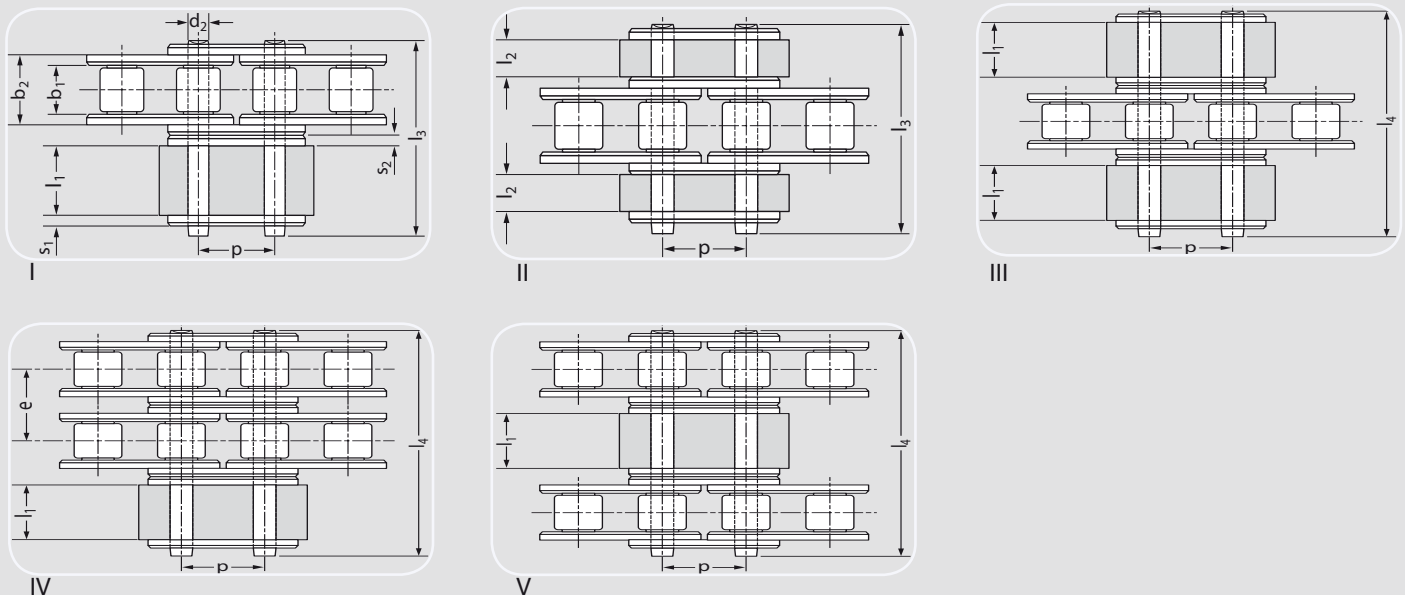

Chain type	pitch p		Inner width b2 max	Transverse e	Plate thickness s1	Plate thickness s2	l1	l2	l3 max.	l4 max.
	mm	inch								
Single- and multiple Roller Chains ISO 606, European Standard DIN 8187										
08 B-1 und 2	12,7	½ "	11,3	13,92	1,7	1,25	11,2	5,6	32,1	46
10 B-1 und 2	15,875	⅝ "	13,28	16,59	1,5		13,2	6,6	37,1	53,9
12 B-1 und 2	19,05	¾ "	15,62	19,46	1,8		15,6	7,8	42,6	62,4
16 B-1 und 2	25,4	1 "	25,4	31,88	3,1		25,3	12,65	69,5	101,4
20 B-1 und 2	31,75	1 ¼ "	29	36,45	3,5		28,9	14,45	80,7	117,2
24 B-1 und 2	38,1	1 ½ "	37,9	48,36	5		37,8	18,9	106,9	155,2
Single- and Multiple Roller Chains ISO 606, American Standard DIN 8188										
08 A-1 und 2	12,7	½ "	11,15	14,48	1,5		11,1	5,55	31,9	46,3
10 A-1 und 2	15,875	⅝ "	13,8	18,11	2		13,7	6,65	39,6	58,9
12 A-1 und 2	19,05	¾ "	17,7	22,78	2,4		17,6	8,6	49,6	72,5
16 A-1 und 2	25,4	1 "	22,5	29,29	3,1		22,4	11,2	64,5	93,6
20 A-1 und 2	31,75	1 ¼ "	27,4	35,76	4		27,3	13,65	79,3	115,1
24 A-1 und 2	38,1	1 ½ "	35,3	45,44	4,7		35,2	17,6	100,3	145,7

Roller Chains with K-Attachments One Bore Hole

Mounted on one or both sides

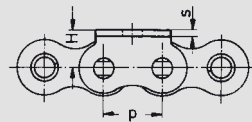
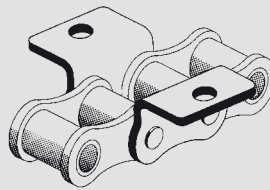
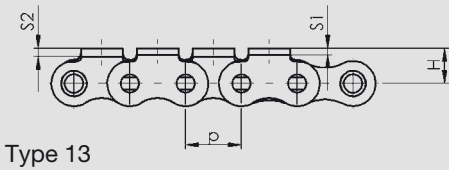

Type 15

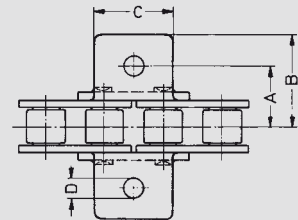
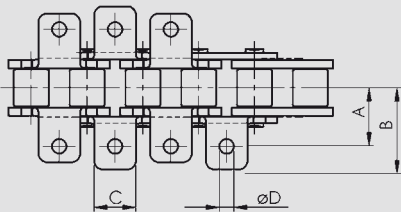

Type of Attachment	Chain description	Name of attachment		Pitch		A	B	C	D	F	G	H	h ₁	h ₂	s ₁	s ₂
		outer	inner	mm	inch	Distance from fixing hole to middle of chain	Width to the middle of chain	Width of the attachment	Diameter of fixing hole	Length of attachment protrusion	Space between the holes	Height of the attachment	Height of fixing hole, exterior	Height of fixing hole, interior	Thickness of material, outer	Thickness of material, inner
13	08 B-1	W 260	W 263	12,7	½ "	13,0	19,3	10,6	4,3			8,5			1,6	1,6
13	08 B-1	W 264	W 269	12,7	½ "	11,9	19,3	10,6	4,3			8,9			1,6	1,6
13	08 B-1	W 266		12,7	½ "	13,8	19,7	10,6	4,3			8,5			1,6	
13	08 B-1	W 270		12,7	½ "	13,0	19,7	10,6	5,4			8,5			1,6	
13	08 B-1	W 276		12,7	½ "	11,9	19,3	10,6	5,4			8,9			1,6	
13	10 B-1	W 302	W 305	15,875	⅝ "	14,9	23,5	12,5	5,4			10,3			1,6	1,6
13	10 B-1	W 304	W 309	15,875	⅝ "	15,9	23,5	12,5	5,1			10,3			1,6	1,6
13	10 B-1	W 340		15,875	⅝ "	16,5	23,5	12,5	5,4			10,3			1,6	
13	10 B-1	W 352		15,875	⅝ "	14,9	23,5	12,5	4,3			10,3			1,6	
13	12 B-1	W 89797	W 12515	19,05	¾ "	19,05	26,5	16	6,4			13,5			1,8	1,8
13	12 B-1		W 12515	19,05	¾ "	19,05	24,6	16	6,4			13,5				1,8
13	12 B-1	W 400	W 405	19,05	¾ "	17,2	28,0	16	5,4			11,9			1,8	1,8
13	12 B-1	W 402		19,05	¾ "	17,7	28,0	16	6,6			11,9			1,8	
13	12 B-1	W 488	W 489	19,05	¾ "	19,05	26,4	16	7,2			13,5			1,8	1,8
13	16 B-1	W 500	W 503	25,4	1 "	26,5	37,5	19	6,6			15,9			3	3

Single and Multiple Roller chains, European Standard DIN 8187, American Standard DIN 8188

Further designs on request!

Roller Chains with K-Attachments

One Bore Hole

Type of Attachment	Chain description	Name of attachment		Pitch		A	B	C	D	F	G	H	h ₁	h ₂	s ₁	s ₂
		outer	inner	mm	inch	Distance from fixing hole to middle of chain	Width to the middle of chain	Width of the attachment	Diameter of fixing hole	Length of attachment protrusion	Space between the holes	Height of the attachment	Height of fixing hole, exterior	Height of fixing hole, interior	Thickness of material, outer	Thickness of material, inner
Single and Multiple Roller chains, European Standard DIN 8187, American Standard DIN 8188																
13	16 B-1	W 502	W 501	25,4	1 "	23,8	37,8	19	6,6			15,2			3	3
13	16 B-1	W 506		25,4	1 "	27	37,9	19	10			18			3	
13	16 B-1	W 526	W 527	25,4	1 "	26,5	37,5	19	8,3			15,9			3	4
13	20 B-1	W 611		31,75	1 ¼ "	32,6	47,4	24	10,5			19,4				3,5
13	08 A-1	W 222	W 223	12,7	½ "	12,7	19,4	10,6	3,5			8,5			1,6	1,6
13	10 A-1	W 322	W 321	15,875	⅝ "	15,8	24,3	12,5	5,4			10,3			2	2
13	12 A-1	W 422		19,05	¾ "	19,05	28,4	16	5,4			11,9			2,4	
13	12 A-1	W 428		19,05	¾ "	19,05	28,4	15,9	8,3			11,9			2,4	
13	16 A-1	W 522	W 523	25,4	1 "	25,4	36,4	20	6,6			15,9			3	3
13	28 A-1		W 983	44,45	1 ¾ "	44,45	55	35,7	11,5			28,6				5,5
13	32 A-1	W 984		50,8	2 "	50,8	70,8	38,5	13,1			31,8			6,3	
15	08 B-1	W 274		12,7	½ "	13,8	20,1	17,9	7,2			8				1,6
15	16 B-1	W 508		25,4	1 "	27	39,5	36	10,3			15,9			3	
15	16 B-1	W 510		25,4	1 "	27	39,5	36	8,3			15,9				3
16	16 B-1	W 580		25,4	1 "	28,5	37,8	45,8	8,5			18			3	
15	16 B-1	W 596		25,4	1 "	29	38,0	24	9			18				3
15	32 B-1	W 838		50,8	2 "	52,5	73	92,4	14			35				6,3
Stainless Steel Single and Multiple Roller chains (RexPlus), European Standard DIN 8187, American Standard DIN 8188																
13	08 B-1 SS	W 280		12,7	½ "	13	19,7	10,6	4,3			8,5			1,6	
13	12 B-1 SS	W 490		19,05	¾ "	17,2	28	16	5,4			11,9			1,8	
13	12 B-1 SS	W 492		19,05	¾ "	17,7	28	16	6,6			11,9			1,8	
13	16 B-1 SS	W 512		25,4	1 "	28,9	37,5	36	9			18			3,1	
13	16 B-1 SS	W 524		25,4	1 "	26,5	37,5	19	6,6			15,9			3,1	
13	16 B-1 SS	W 528	W 529	25,4	1 "	26,5	37,5	18,6	6,6			15,9			3,1	3,7
13	16 B-1 SS	W 97654	W 97655	25,4	1 "	26,5	37,5	18,6	8,3			15,9			3,1	3,7
13	10 A-1 SS	W 380		15,875	⅝ "	15,8	24,3	12,5	5,4			10,3			2	
Double Pitch Roller Chains, European Standard DIN 8187, American Standard DIN 8181																
13	208 B	W 548	W 549	25,4	1 "	14	20,4	20	4,4			9			1,6	1,6
13	210 B		W 635	31,75	1 ¼ "	15,8	28,3	25	5,4			11,2				1,6
13	212 B	W 650		38,1	1 ½ "	20,9	34,9	31,8	6,6			14,5			1,8	
13	216 B	W 830		50,8	2 "	28,8	42,1	39,8	8,3			17			3	
13	208 A	W 552		25,4	1 "	12,7	20,4	20	4,3			9			1,6	
13	208 A	W 554		25,4	1 "	12,7	20,4	20	5,4			9			1,6	
13	208 A	W 45497		25,4	1 "	12,7	20,4	20	5,1			9			1,6	
13	210 A	W 19586		31,75	1 ¼ "	15,8	22,3	25	5,4			11,2			2	
13	212 A	W 658		38,1	1 ½ "	19,05	31,2	28	6,6			14,5			2,4	
13	212 A H	W 662		38,1	1 ½ "	21,4	33,2	28	6,6			14,7			3,1	
13	216 A SS	W 62166		50,8	2 "	27,8	41,1	39,8	8,3			18			3,1	

Further designs on request!

Roller Chains with K-Attachments Two Bore Holes

Mounted on one or both sides

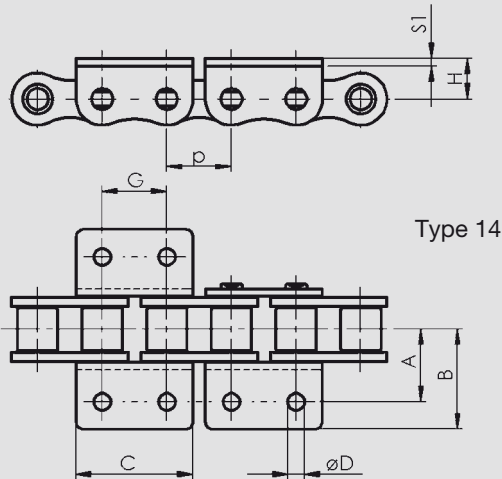

Type of Attachment	Chain description	Name of attachment		Pitch		A	B	C	D	F	G	H	h ₁	h ₂	s ₁	s ₂
		outer	inner	mm	inch	Distance from fixing hole to middle of chain	Width to the middle of chain	Width of the attachment	Diameter of fixing hole	Length of attachment protrusion	Space between the holes	Height of the attachment	Height of fixing hole, exterior	Height of fixing hole, interior	Thickness of material, outer	Thickness of material, inner
Single and Multiple Roller chains, European Standard DIN 8187, American Standard DIN 8188																
14	08 B-1	W 188	W 189	12,7	½ "	13	19,7	24,4	4,3		12,7	8,5			1,6	1,6
14	08 B-1	W 190		12,7	½ "	12,7	20,7	24,4	4,9		12,7	9,9			1,6	
14	10 B-1	W 346		15,875	⅝ "	15	21,1	28,6	5,1		15,77	10,3			1,6	
14	12 B-1	W 450		19,05	¾ "	18	27,7	35,2	6,6		19,05	12			1,8	
14	12 B-1	W 456		19,05	¾ "	17,5	26,1	35	5,4		19,05	11,4			1,8	
14	16 B-1	W 572		25,4	1 "	25,4	36,8	45,8	8,3		25	19			3	
14	16 B-1	W 576		25,4	1 "	28,7	40	46	8,3		25,4	15,9			3	
14	20 B-1	W 612		31,75	1 ¼ "	33,4	43	47	8,1		30	22			3,5	
14	24 B-1	W 740		38,1	1 ½ "	43,6	61,8	71,1	10,5		38,1	32			5	
14	28 B-1	W 82		44,45	1 ¾ "	44,45	67,9	81,5	13,5		44,45	28,6			5,5	
14	32 B-1	W 840		50,8	2 "	52,6	74,1	92,4	12,5		50,8	35			6,3	
14	32 B-1	W 842		50,8	2 "	47,7	58,6	92,4	14		50,8	35			6,3	
14	32 B-1	W 116846		50,8	2 "	52,6	74,1	92,4	14		50,8	35			6,3	
14	12 A-1	W 111934		19,05	¾ "	19,5	26,7	36	6,6		19,05	11,5			2,4	
14	28 A-1	W 91410		44,45	1 ¾ "	34,7	49,4	81,5	11,2		42	25			5,5	
14	28 A-1	W 762		44,45	1 ¾ "	17,25	31,7	49,4	10,3		42	25			5,5	
Stainless Steel Single and Multiple Roller chains (RexPlus), European Standard DIN 8187, American Standard DIN 8188																
14	08 B-1 SS	W 294		12,7	½ "	13	19,7	24,4	4,3		12,7	8,5			1,6	
14	10 B-1 SS	W 394		15,875	⅝ "	15,6	21,1	28,6	5,1		15,8	10,3			1,6	
14	12 B-1 SS	W 494		19,05	¾ "	18	27,6	35,2	6,6		19,05	12			2	
14	16 B-1 SS	W 574		25,4	1 "	25,4	36,8	45,8	8,3		25	19			3,1	
14	16 B-1 SS	W 121148		25,4	1 "	28,8	37,8	45,8	9		25	18			3,1	

Further designs on request!

Roller Chains with Extended Pins

Extended on one side – Type 35
Extended on both sides – Type 36

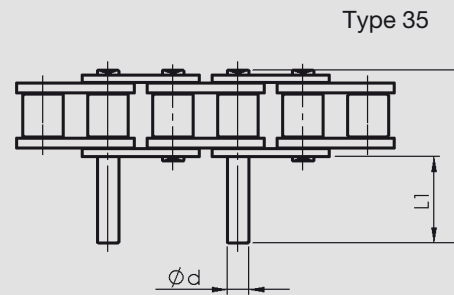
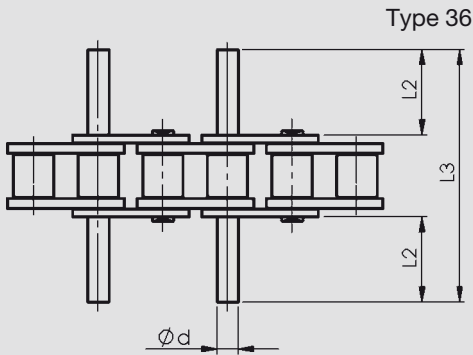
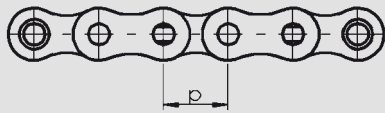

Attachment Type	Chain No.	Name of Attachment	Pitch p		d Pin diametre	l1 Pin gap one side	l2 Pin gap both sides	l3 Overall width
			mm	inch				
Single and Multiple Roller chains, European Standard DIN 8187, American Standard DIN 8188								
35 + 36	08 B-1	BGL 08 B-2 *	12,7	½ "	4,45	15	8	31
35 + 36	08 B-1	BGL 08 B-3 *	12,7	½ "	4,45	29	15	44,9
35 + 36	10 B-1	BGL 10 B-2 *	15,875	⅝ "	5,08	17,8	9,5	35,5
35 + 36	10 B-1	BGL 10 B-3 *	15,875	⅝ "	5,08	34,4	17,8	52,2
35 + 36	12 B-1	BGL 12 B-2 *	19,05	¾ "	5,72	20,8	11	41,7
35 + 36	12 B-1	BGL 12 B-3 *	19,05	¾ "	5,72	40,2	20,8	61,3
35 + 36	16 B-1	BGL 16 B-2 *	25,4	1 "	8,28	33,6	17,6	67,4
35 + 36	16 B-1	BGL 16 B-3 *	25,4	1 "	8,28	65,5	33,6	99,3
35 + 36	20 B-1	BGL 20 B-2	31,75	1 ¼ "	10,19	38,3	20,1	76,9
35 + 36	20 B-1	BGL 20 B-3	31,75	1 ¼ "	10,19	74,8	38,3	113,4
35 + 36	24 B-1	BGL 24 B-2	38,1	1 ½ "	14,63	51,2	26,8	102,2
35 + 36	24 B-1	BGL 24 B-3	38,1	1 ½ "	14,63	99,2	50,8	150
35 + 36	08 A-1	BGL 08 A-2	12,7	½ "	3,96	15,3	8,1	30,7
35 + 36	08 A-1	BGL 08 A-3	12,7	½ "	3,96	29,7	15,3	45,1
35 + 36	10 A-1	BGL 10 A-2	15,875	⅝ "	5,08	19,2	10,2	38,5
35 + 36	10 A-1	BGL 10 A-3	15,875	⅝ "	5,08	37,3	19,2	56,7
35 + 36	12 A-1	BGL 12 A-2	19,05	¾ "	5,94	24,2	12,8	48,5
35 + 36	12 A-1	BGL 12 A-3	19,05	¾ "	5,94	46,9	24,2	71,3
35 + 36	16 A-1	BGL 16 A-2	25,4	1 "	7,92	31,3	16,6	62,5
35 + 36	16 A-1	BGL 16 A-3	25,4	1 "	7,92	60,6	31,3	91,7
35 + 36	20 A-1	BGL 20 A-2	31,75	1 ¼ "	9,53	37,6	19,7	75,3
35 + 36	20 A-1	BGL 20 A-3	31,75	1 ¼ "	9,53	73,4	37,6	111,2

Type 35 and 36 of European standard up to 1" are also available in RexPlus!

* Regarding Quick Step Programme: Only Type 35 is available with Quick Step.

Further designs on request!

Roller Chains with Extended Pins

Extended on one side – Type 35
Extended on both sides – Type 36

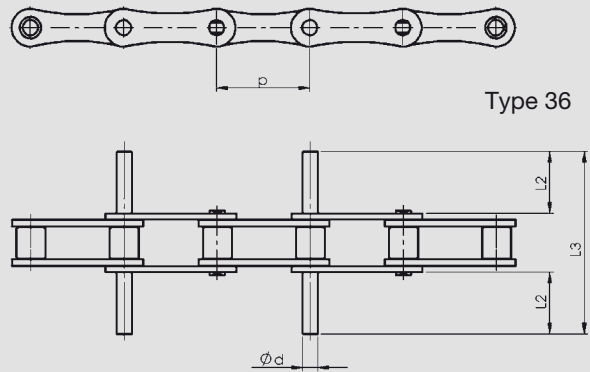

Attachment Type	Chain No.	Name of Attachment	Pitch p		d Pin diameter	l1 Pin gap one side	l2 Pin gap both sides	l3 Overall width
			mm	inch				
Double Pitch Roller Chains, European Standard DIN 8181, American Standard DIN 8181								
35 + 36	208 B	BGL 08 B-2	25,4	1 "	4,45	15	8	31
35 + 36	208 B	BGL 08 B-3	25,4	1 "	4,45	29	15	44,9
35 + 36	210 B	BGL 10 B-2	31,75	1 ¼ "	5,08	17,8	9,5	35,5
35 + 36	210 B	BGL 10 B-3	31,75	1 ¼ "	5,08	34,4	17,8	52,2
35 + 36	212 B	BGL 12 B-2	38,1	1 ½ "	5,72	20,8	11	41,7
35 + 36	212 B	BGL 12 B-3	38,1	1 ½ "	5,72	40,2	20,8	61,3
35 + 36	216 B	BGL 16 B-2	50,8	2 "	8,28	33,6	17,6	67,4
35 + 36	216 B	BGL 16 B-3	50,8	2 "	8,28	65,5	33,6	99,3
35 + 36	208 A	BGL 08 A-2	25,4	1 "	3,96	15,3	8,1	30,7
35 + 36	208 A	BGL 08 A-3	25,4	1 "	3,96	29,7	15,3	45,1
35 + 36	210 A	BGL 10 A-2	31,75	1 ¼ "	5,08	19,2	10,2	38,5
35 + 36	210 A	BGL 10 A-3	31,75	1 ¼ "	5,08	37,3	19,2	56,7
35 + 36	212 A	BGL 12 A-2	38,1	1 ½ "	5,94	24,2	12,8	48,5
35 + 36	212 A	BGL 12 A-3	38,1	1 ½ "	5,94	46,9	24,2	71,3
35 + 36	216 A	BGL 16 A-2	50,8	2 "	7,92	31,3	16,6	62,5
35 + 36	216 A	BGL 16 A-3	50,8	2 "	7,92	60,6	31,3	91,7

Pin dimensions for double pitch roller chains, American Standard, with straight and heavy link plates correspond to the dimensions of the ANSI series.

Stainless steel roller chains with extended pins correspond to the dimensions of standard chain.

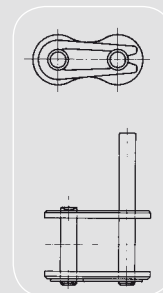

With one extended pin

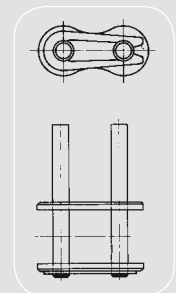

With two extended pins

Chains up to 25,4 pitch: Connecting links with spring clip
Chains 31,75 pitch and above: Connecting link with cotter

Further designs on request!

The Click Attachment System



Mounted Click Attachment system (type A)
on the bottom side



Mounted Click Attachment system (type B)

The Rexnord Click Attachment System is an easy to handle and very effective problem solution.

A type A plastic part is integrated into the chain design by „clicking“ it onto the inner links of the chain. A type B plastic U-Clip is integrated by “clicking” it onto the outer plates. This enables a careful transportation of sensitive products without any problem.

Roof tiles, tin boxes with individual parts, as well as food products are transported with the help of the Chain Click System.

The large advantage is the good price/performance relationship.

The wear of the plastic parts does not result in the replacement of the entire chain, as replacement attachments can be supplied. The Click Attachments must be used with single and multiple strand roller chains of BS standard DIN/ISO 8187, Roller Chains with straight plates, non corrosive chains, chains with surface treatment (zinc and/or nickel plated), and sidebow chains.

The selected material contains absolutely no silicon.

Chain type	type	pitch p		Click Material	Click Attachment height H [mm]	Max. allowable load weight/each click M/pro click kg	Max. allowable Chain tension each strand F*
		mm	inch				
08 B Clip	A	12,7	½ "	Polyamid reinforced	7,8	80 kg	1250 N
10 B Clip	A	15,875	⅝ "		9,8	100 kg	1750 N
12 B Clip	A	19,05	¾ "		11	120 kg	2500 N
16 B Clip	A	25,4	1 "		14,5	160 kg	5500 N
16 B Clip	B	25,4	1 "	High performance polymer			
20 B Clip	B	31,75	1 ¼ "				

* Double Strand = F x 1,8
Triple Strand = F x 2,5

Pin Oven Chains

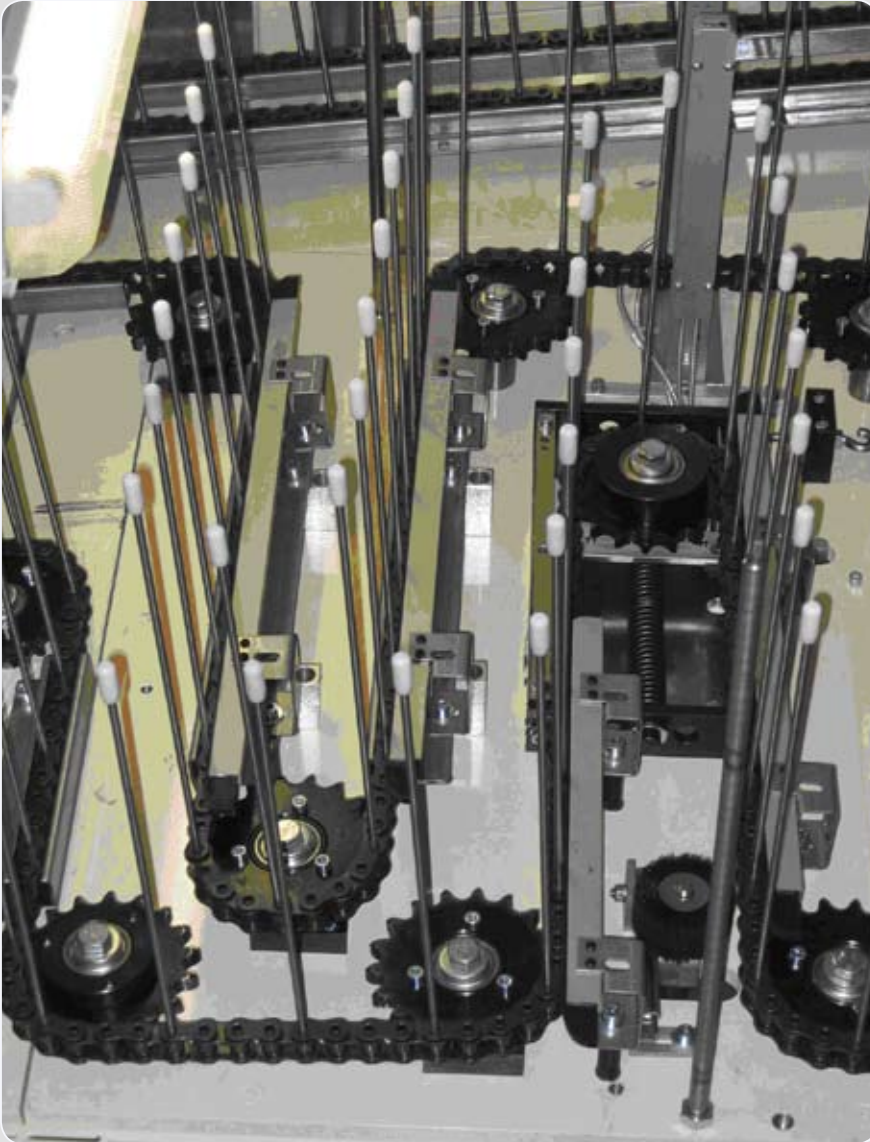

Example of use of an pin oven chain

Different roller chains and hollow pin chains according to ISO 606 are used for transport of cans and collapsible tubes between the production process steps.

Different pitches, standards and measurements of pin oven are possible. If required, the end of every pin oven can be assembled with a protective cap for protecting the products and prevent damages.

Pin ovens are available in spring steel and stainless design.

For cleaning cans, a special solution can be the use of our curved wire, stainless chains.

Please do not hesitate to contact our application engineers for an optimised solution for your individual application!

Roller chains ISO 606 with pin ovens are available in sizes $\frac{1}{2}$ inch to $\frac{3}{4}$ inch; Hollow pin chains with pin ovens are available in sizes $\frac{5}{8}$ inch to 1 inch. These chain types are also shown in our Quality Chains catalogue.

Pin Oven Chains

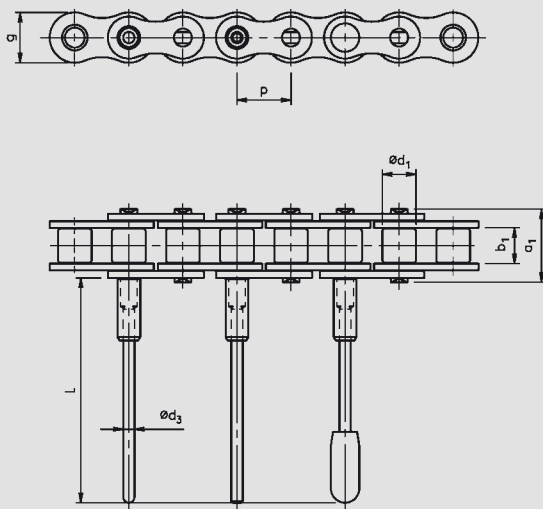

Technical drawing of roller chain with three different designs of pin ovens. Measurement L and equivalent design determined on agreement.

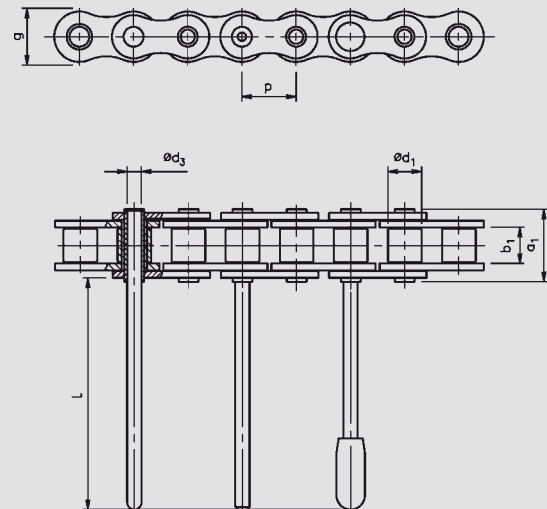

Technical drawing of hollow pin chain with three different designs of pin ovens. Measurement L and equivalent design determined on agreement.

Chain no.	pitch p		Roller width, b ¹ min.	Roller diameter, d ¹ max.	Pin diameter, d ² max.	Hollow pin inner diameter, d ³ min.	Roller link width, b ² max.	Link plate height, g	Pin length, a ¹ max.	Overall width, a ³ max.	Bearing area, A	Min. ultimate strength according to DIN / ISO, F _B	Weight	curved wire
	inch	mm												
Single Hollow pin Roller Chain, Main dimensions acc. to ISO 606, European and American Standard														
10 B - 1 HB	5/8"	15,875	9,65	10,16	5,94	4	13,9	14,7	19,3	21,1	1,14	17 000	0,8	
12 B - 1 HB	3/4"	19,05	11,68	12,07	6,5	4	16,3	15,9	22,4	24	1,06	21 000	1,1	
08 A - 1 HB	1/2"	12,7	7,85	7,95	5,72	4	11,9	11,6	17,1	18,5	0,68	10 000	0,53	
12 A - 1 HB	3/4"	19,05	12,57	11,91	7	5	18,65	17,7	26,3	27,2	1,3	20 000	1,32	
16 A - 1 HB	1	25,4	15,75	15,88	11,67	8	22,5	23,7	32,6	33,7	2,63	59 000	2,4	
Double Hollow pin Roller Chain, Main dimensions acc. to ISO 606, European Standard DIN 8187														
10 B - 2 HB	5/8"	15,875	9,65	10,16	5,94	4	13,9	14,7	37,3	39	2,08	33 500	1,6	
12 B - 2 HB	3/4"	19,05	11,68	12,07	6,5	4	16,3	15,9	43	45	2,12	42 500	2,2	
Sidebow Roller Chains														
63 SS	3/4"	19,05	18,7	11,91	5,08		12,6	15,2	29,1	27,1	0,89	14 000	0,832	356
Single and Multiple Roller chains, European Standard DIN 8187, American Standard DIN 8188														
08 B	1/2"	12,7	7,75	8,51	4,45		11,3	11,6	17,0	19,0	0,50	18 000	0,7	
10 B	5/8"	15,875	9,65	10,16	5,08		13,28	14,6	19,6	22,0	0,67	22 400	0,9	
12 B	3/4"	19,05	11,68	12,07	5,72		15,62	15,9	22,7	25,1	0,89	29 000	1,15	
12 A	3/4"	19,05	12,57	11,91	5,94		17,7	17,7	25,7	28,6	1,05	31 800	1,48	

Further designs on request!



Timber Industry – High Functionality and Reliability

For almost all areas of wood-working, Rexnord offers the correct solution with a variety of attachments.

For molding and trimming technology, a wide range of jagged connecting plates and special attachments for secure transport is available. A rate of feed of up to 150 meters per minute can be achieved with Rexnord's high performance roller chains. Serrated plates, arranged in different designs provide each individual job with a high or very low friction coefficient between transport goods and chains.

In the fields of high speed board conveyance and grading plants, Rexnord chains prove themselves through strong, wear-resistant surfaces and joints. The highest operational stability is achieved through an optimal tight fit, as well as through a high impact load. For sensitive surfaces, Rexnord offers rubberized clamps,

high performance roller chains with straight plates, or the Rexnord Chain Click System.

Rexnord roller chains not only provide solutions for high-speed applications, but can also meet other demanding requirements. For exact positioning and manipulation of various products, Rexnord high performance roller chains can be aligned with one another in pairs or in groups. Chains which are set parallel to one another can therefore be guaranteed to have even load distribution within the chain strand. An inspection of the amount of twist present in long conveying lines satisfies every requirement of the product profile.

The Rexnord consulting team will also offer you support in choosing the appropriate lubrication specifically for the timber industry. Therefore, you can use chains with a dry wax lubrication, as well as chains which are sparingly externally lubricated.

Typical Attachments for the Timber Industry

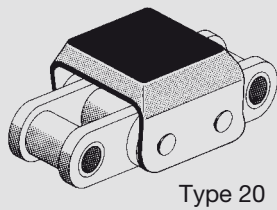

Type 20

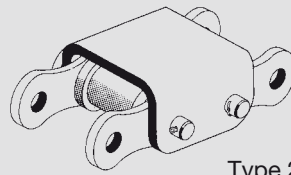
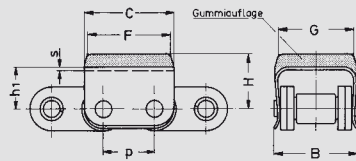

Type 25

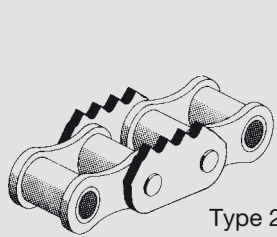
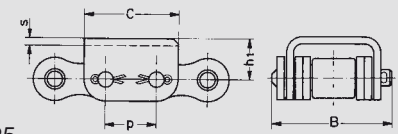

Type 22

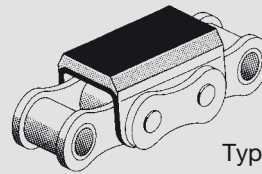
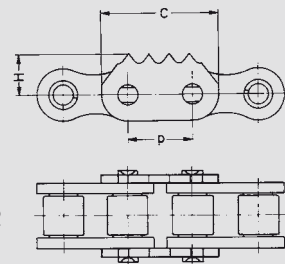

Type 26

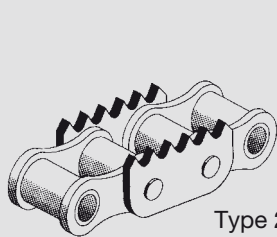
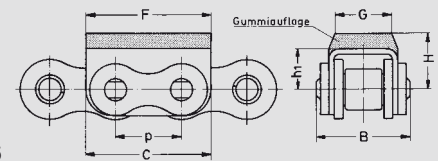

Type 23

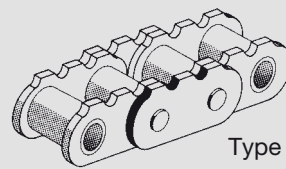
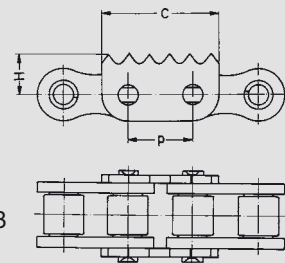

Type 30

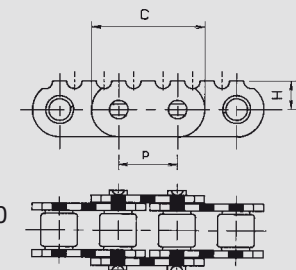

Type of Attachment	Chain description	Name of attachment		Pitch		A	B	C	D	F	G	H	h ₁	h ₂	s ₁	s ₂
		outer	inner	mm	inch	Distance from fixing hole to middle of chain	Width to the middle of chain	Width of the attachment	Diameter of fixing hole	Length of attachment protrusion	Space between the holes	Height of the attachment	Height of fixing hole, exterior	Height of fixing hole, interior	Thickness of material, outer	Thickness of material, inner
20	08 B-2	Z 232*		12,7	½ "		33,5	24					8,5		0,8	
20	08 B-2	Z 299		12,7	½ "		33,5	24	23	24	12,5	8,5			0,8	
20	08 B-2	Z 332***		12,7	½ "		33,5	24	18	21	12,5	8,5			0,8	
20	20-1	Z 474*		20	0,787		35,5	36	31	27	21	16			1,2	
20	20-1	Z 528		20	0,787		35,5	36				16			1,2	
22	16 B-1	M 506		25,4	1 "			46				15,9			3,1	
23	16 B-1	M 516		25,4	1 "			46				15,9			3,1	
23	20 B-1	M 76138		31,75	1 ¼ "			47				20			3,5	
25	20-1 (old: Re 487)	Z 186		20	0,787		29,5	36				16			3	
26	16 A-1	Z 530*		25,4	1 "			48	48	22	21,5	15,5			2	
26	16 A-1	Z 329**		25,4	1 "			48	48	22	23,6	15,6			1,95	
30	16 B-1	M 1797	M 1796	25,4	1 "			45,7			12,65	12			3	3,75
30	32 B-1	M 117609	M 117610	50,8	2 "			92,7			12,7	30			6,3	7
30	12 A-1	M 498	M499	19,05	¾ "			36,6			9,5	9,2		2,4		
30	20 A-1	M 87531	M 87532	31,75	1 ¼ "			61			10,6	18,4			4	4
30	24 A-1	M 111596		38,1	1 ½ "			72,8			12,7	21,1			9,4	
30	24 A-1	M 111594		38,1	1 ½ "			72,8			12,7	21,1			10	
30	24 A-1	M 704	M 705	38,1	1 ½ "			72,8			12,7	21,1			4,7	4,7

* without rubber top

** rubber top in black. Also available in light-beige (designation of attachment: Z 16214), white (Z 1051) or dark grey (Z 951).

*** rubber top in beige. Also available in black (Z 1006) or light-grey (Z 1087).

Further designs on request!



Food Industry

Rexnord roller chains can be found in many applications, including many areas of the food industry.

For many years, Rexnord chains have been effectively implemented for various uses in bottling plants, creameries, smoke houses, or in fish processing. Moreover, Rexnord chains are being used in refrigerated warehouses and in ovens in the bread making industry.

Rexnord chains are therefore able to satisfy your most important requirements.

Continuous further development, joint cooperation with customers in formulating new drive and conveying concepts, as well as the design of new attachment types, offers the basis for long lasting collaboration.

High precision of individual components paired with matching roller chains, minor tolerance and elasticity, high hygiene standards, as well as high equipment availability, illustrate purchasing decision requirements in application areas of the food industry

The corresponding lubrication with H1 registration, appropriate for high and low temperatures, along with corrosion resistant surfaces, and finally, the impressive wear characteristics of chain links, round out the overall profile of Rexnord chains for the food industry.

Experience, which we have gained through numerous varying applications, make us the most competent partner for food and beverage technology.

Typical Attachments for the Food Industry

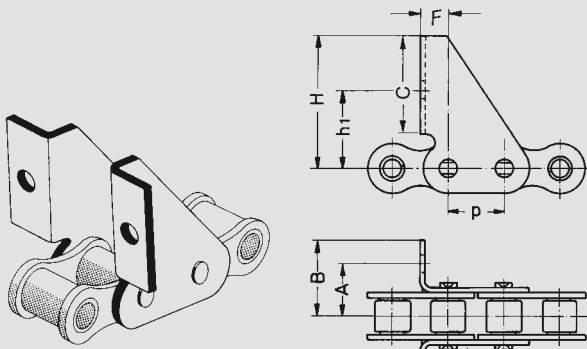

Type 4

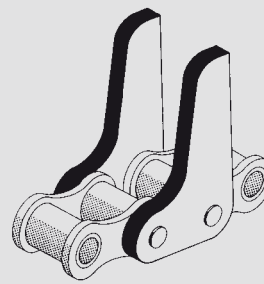

Type 5

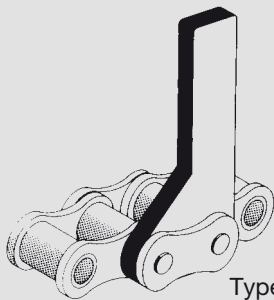

Type 7

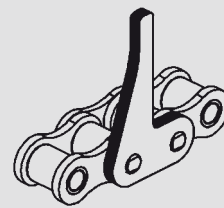

Type 66

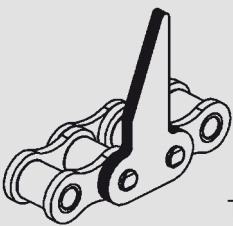

Type 8

Type of Attachment	Chain description	Name of attachment		Pitch		A	B	C	D	F	G	H	h ₁	h ₂	s ₁	s ₂
		outer	inner	mm	inch	Distance from fixing hole to middle of chain	Width to the middle of chain	Width of the attachment	Diameter of fixing hole	Length of attachment protrusion	Space between the holes	Height of the attachment	Height of fixing hole, exterior	Height of fixing hole, interior	Thickness of material, outer	Thickness of material, inner
4	10 B-1	F 308		15,875	5/8"	14,8	21,5	28	5,1	8		37,5	23		1,6	
4	20-1 (old: Re 487)	F 538		25,4	1"		36	28		8		46			3	
5	10 B-1	M 316		15,875	5/8"			29,8				41			4	
7	12 B-1	M 416		19,05	3/4"			35				70			5,5	
7	12 B-1	M 115098		19,05	3/4"			35				48			5,5	
7	12 B-1	M 110678		19,05	3/4"			35				70			5,5	
8	16 B-1	M 158		25,4	1"		25,0	46				50	20		5	
8	16 B-1	M 184		25,4	1"		25,0	46				55	20		5	
8	16 B-1	M 185		25,4	1"		25,0	46				45	20		5	
8	16 B-1	M 515		25,4	1"		25,0	46				65	20		5	
66	212 A	M 832		38,1	1 1/2"		8			19,5		80			5	
66	212 A	M 151		38,1	1 1/2"		10			15		40			5	

Further designs on request!



Packaging Industry

Rexnord Chains have also proven themselves to be effective when used in the packaging industry.

The role of conveying chains, which are used to transfer pieces from containers during production or for positioning from foil, can be filled by Rexnord chains.

In the packaging industry, high work cycle accuracy, low elasticity, equipment availability and absolute operational safety are demanded. Non-drip, ex-works, special lubrication is an important prerequisite in order to ensure consistently high product quality.

In addition, the rigorous requirements demanded by reversing service, high acceleration or start/stop service show the high fatigue strength of Rexnord chains.

Many different solutions have already been successfully implemented in the packaging industry with Rexnord high performance roller chains. They are able to fulfill the highest quality standards demanded by customers.

Through the continuous further development of our production and the further optimization of all components, the quality of Rexnord products is continually improved. Therefore, Rexnord Kette and its customers will always be prepared for any challenges that may arise in the future.

Because of the modular construction of a roller chain, the simple assembly of various special attachments can be guaranteed, allowing for the realization of solutions for nearly every application, as well as a minimization of costs.

Typical Attachments for the Packaging Industry

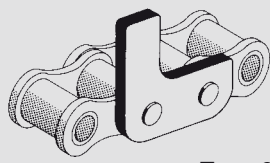

Type 6

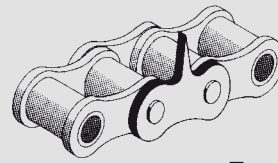
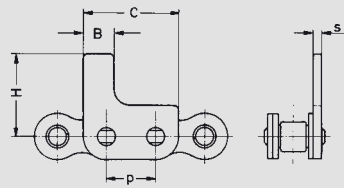

Type 21

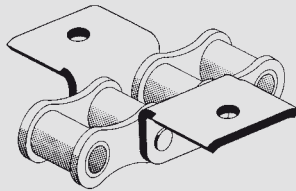
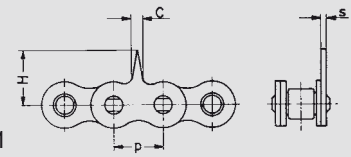

Type 16

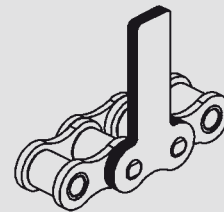
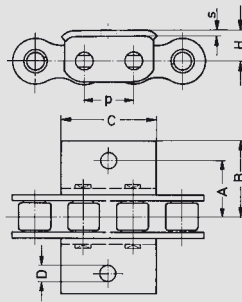

Type 60

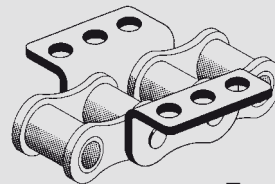
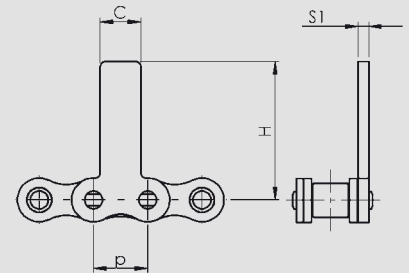

Type 17

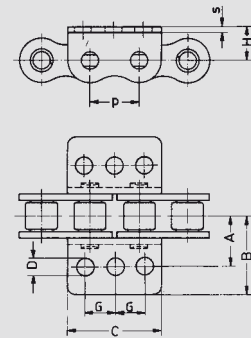

Type of Attachment	Chain description	Name of attachment		Pitch		A	B	C	D	F	G	H	h ₁	h ₂	s ₁	s ₂
		outer	inner	mm	inch	Distance from fixing hole to middle of chain	Width to the middle of chain	Width of the attachment	Diameter of fixing hole	Length of attachment protrusion	Space between the holes	Height of the attachment	Height of fixing hole, exterior	Height of fixing hole, interior	Thickness of material, outer	Thickness of material, inner
6	10 B-1	M 328		15,875	5/8 "							26,5			3,1	
16	20-1 (old: Re 487)	W 470		20	0,787		36,8	35				11			3	
16	20-1 (old: Re 487)	W 472		20	0,787	28	36,8	35	6,6			11			3	
17	08 B-1	W 112568		12,7	1/2 "	16,4	24	24,4	6,6	2,5	8,75	8			1,6	
17	12 B-1	W 107157		19,05	3/4 "	18,6	26	35,2	6,6	2,5	8,75	11,5			1,8	
17	16 B-1 BG	W 536		25,4	1 "	18,6	25,8	35	6,6		11	11,2			3	
17	12 A-1	W 424*		19,05	3/4 "	19,5	26,7	36	6,6		11,5	11,5			2,4	
21	08 B-1 SS	M 69766		12,7	1/2 "			9				14,6			1,6	
21	08 B-1	M 64136		12,7	1/2 "			9				14,6			1,6	
21	10 A-1	M 354		15,875	5/8 "			8,6				17			2	
21	10 A-1	M 348		15,875	5/8 "			8,6				17			2	
60	16 B-1	M 71740		25,4	1 "			25				90			5	
60	20-1 (old: Re 487)	M 64617		20	0,787			20				50			3,9	
60	20-1 (old: Re 487)	M 60121		20	0,787			20				54			3,9	
60	20-1 (old: Re 487)	M 462		20	0,787			20				64,5			3,9	

* Also available for double-pitch roller chains. Further designs on request!

Special Attachments

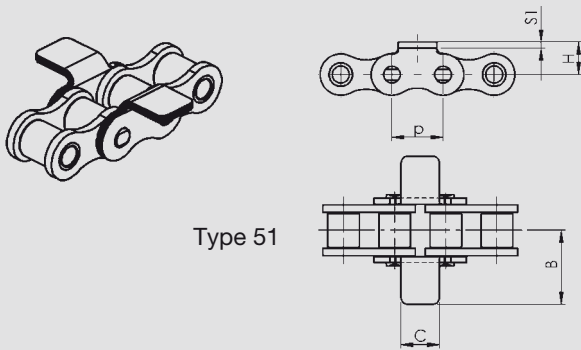

Type 51

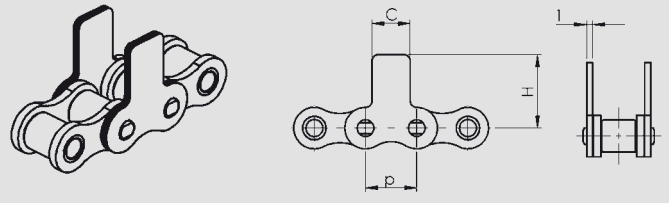

Type 61

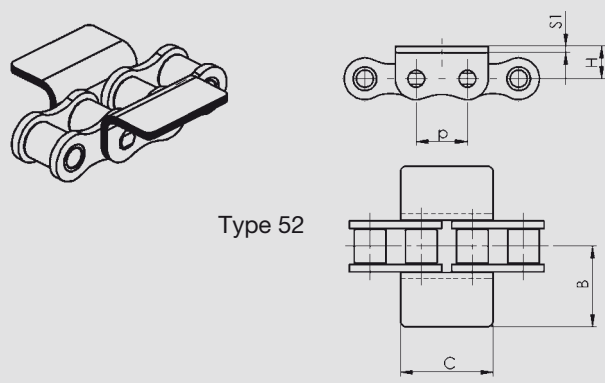

Type 52

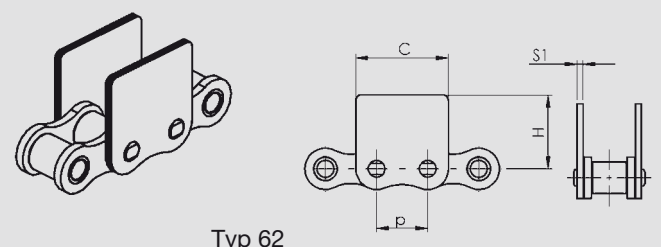

Typ 62

Type of Attachment	Chain description	Name of attachment		Pitch		A	B	C	D	F	G	H	h ₁	h ₂	s ₁	s ₂
		outer	inner	mm	inch	Distance from fixing hole to middle of chain	Width to the middle of chain	Width of the attachment	Diameter of fixing hole	Length of attachment protrusion	Space between the holes	Height of the attachment	Height of fixing hole, exterior	Height of fixing hole, interior	Thickness of material, outer	Thickness of material, inner
51	210 A	W 116643		31,75	1 ¼"		22,5	25				11,2			2	
51	210 A	W 116641		31,75	1 ¼"		26,3	25				11,2			2	
52	08 B-1	W 24920		12,7	½"		19,7	24,4				8,5			1,6	
52	08 B-1	W 123806		12,7	½"		19,7	19,5				8,5			1,6	
52	12 B-1	W 454		19,05	¾"		29,8	35,2				11,9			1,8	
61	08 B-1	M 262		12,7	½"			10,6				19			1,6	
61	10 B-1	M 124942		15,875	⅝"			10				18			1,6	
61	20-1 (old: Re 487)	M 456		20	0,787			20				45			3,9	
61	20-1 (old: Re 487)	M 464		20	0,787			20				39			3,9	
61	16 B-1	M 548		25,4	1"			25				65			5	
61	216 B	M 836		50,8	2"			39,8				39,8			3,1	
62	08 B-1	M 112548		12,7	½"			23,2				16			1,6	
62	12 B-1	M 18467		19,05	¾"			35,2				29,8			1,8	
62	12 A-1		M 118345	19,05	¾"			35,2				24				2,4

Further designs on request!

Special Attachments

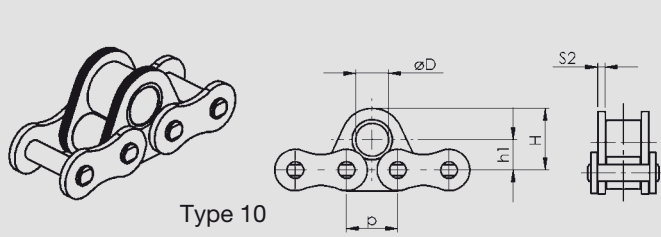

Type 10

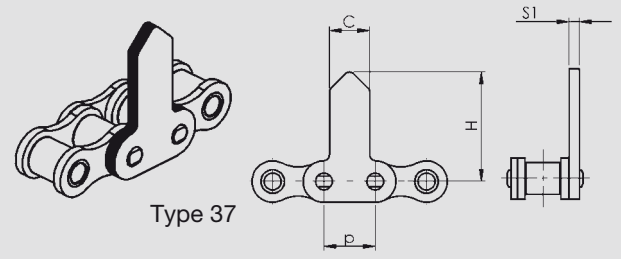

Type 37

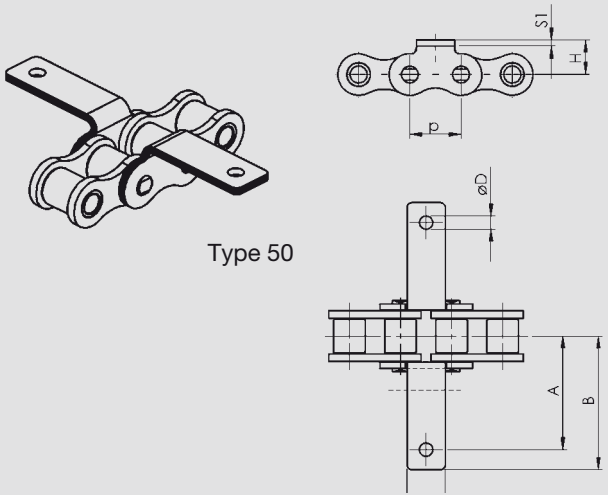

Type 50

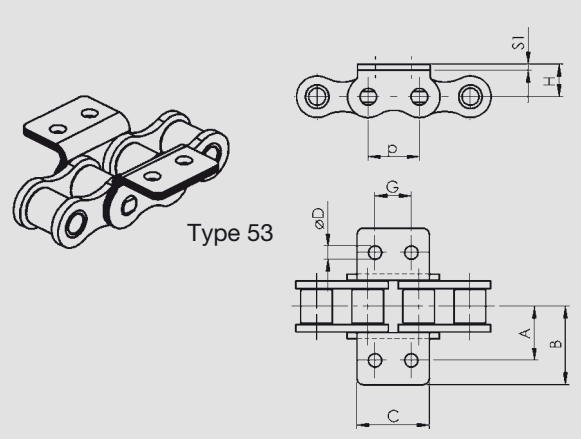

Type 53

Type of Attachment	Chain description	Name of attachment		Pitch		A	B	C	D	F	G	H	h1	h2	s1	s2
		outer	inner	mm	inch	Distance from fixing hole to middle of chain	Width to the middle of chain	Width of the attachment	Diameter of fixing hole	Length of attachment protrusion	Space between the holes	Height of the attachment	Height of fixing hole, exterior	Height of fixing hole, interior	Thickness of material, outer	Thickness of material, inner
10	30-1 (old: Re 626)	M 587		30					16			31	15			
37	20-1 (old: Re 487)	M 462		20	0,787			20				64,5			3,9	
50	08 B-1	W 68905		12,7	½ "	23,8	32,2	13	6,2			8,5			1,6	
50	10 B-1	W 68920		15,875	5/8 "	24,8	33,3	15	6,2			10,3			1,6	
53	212 A H SS	W 111173	W 17189	38,1	1 ½ "	21,5	31	28	5,1		14,4	14,7			3,1	3,1
53	212 A H SS	W 16687	W 17189	38,1	1 ½ "	21,5	33,1	28	5,1		14,4	14,7			3,1	3,1
53	212 A H SS		W 17189	38,1	1 ½ "	21,5	29,6	28	5,1		14,4	14,7				3,1
53	212 B	W 678		38,1	1 ½ "	17,6	31,5	28	6,6		15	12,2			1,8	

Further designs on request!

Special Attachments

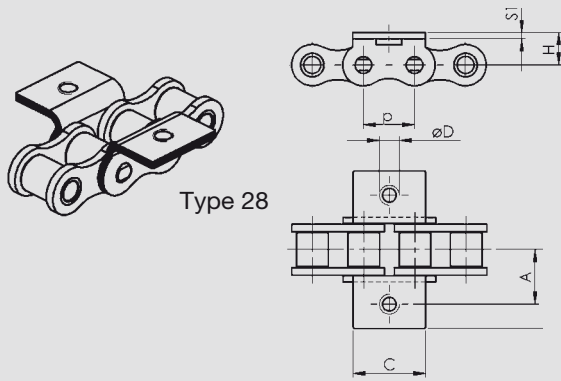

Type 28

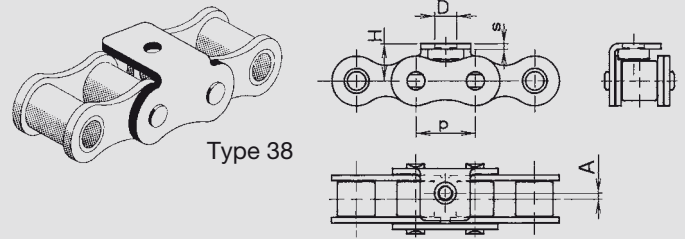

Type 38

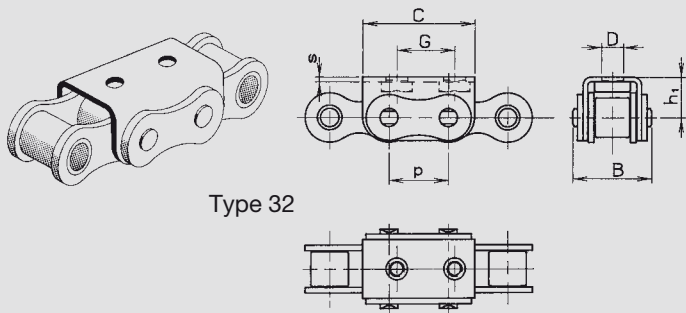

Type 32

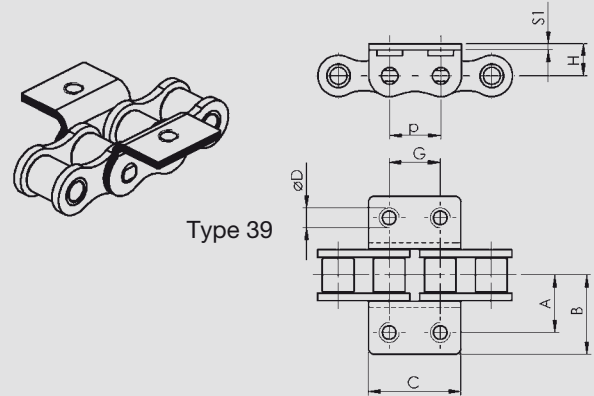

Type 39

Type of Attachment	Chain description	Name of attachment		Pitch		A	B	C	D	F	G	H	h ₁	h ₂	s ₁	s ₂
		outer	inner	mm	inch	Distance from fixing hole to middle of chain	Width to the middle of chain	Width of the attachment	Diameter of fixing hole	Length of attachment protrusion	Space between the holes	Height of the attachment	Height of fixing hole, exterior	Height of fixing hole, interior	Thickness of material, outer	Thickness of material, inner
28	08 B-1	W 109363M5		12,7	½ "	13	19,7	10,6	M5			8,5			1,6	
28	08 B-1	W 111693		12,7	½ "	15,8	20,1	17,9	M5			8			1,6	
28	08 B-1	W 109747		12,7	½ "	13,8	20,1	17,9	M5			8			1,6	
28	10 B-1	W 324M6		15,875	⅝ "	15,4	23,5	12,5	M6			10,3			2	
28	10 B-1	W 118054M5		15,875	⅝ "	14,9	23,5	12,5	M5			10,3			1,6	
28	10 B-1	W 119038 M5		15,875	⅝ "	15,9	23,5	12,5	M5			10,3			1,6	
28	12 B-1	W 107737 M5		19,05	¾ "	17,7	28	16	M5			11,9			1,8	
28	16 B-1	W 596M8		25,4	1 "	29	38	24	M8			18			3	
28	16 B-1	W 510M6		25,4	1 "	27	39,5	36	M6			15,9			3	
28	16 B-1	W 508M8		25,4	1 "	27	39,5	36	M8			15,9			3	
28	08 B-1 SS	W 104533M4		12,7	½ "	13,2	19,7	10,6	M4			8,5			1,6	
28	08 B-1 SS		W 104534M4	12,7	½ "	9,5	17,4	10,6	M4			8,5				1,6
28	12 B-1 SS	W 125698M6		19,05	¾ "	17,7	28	16	M6			11,9			1,8	
28	212 A H	W 104235M6		38,1	1 ½ "	21,4	33,6	28	M6			14,7			3,1	
32	16 A-1	Z 433		25,4	1 "		36,9	48	M6		24		15,5		2	
38	08 B-1 SS	W 104533M4	W 104534M4	12,7	½ "	0			M4			8,5			1,6	1,6
38	16 B-1	W 508M8		25,4	1 "	1,9			M8			15,9			3	
39	10 B-1	W 122183 M5		15,875	⅝ "	15	21,1	28,6	M5		15,8	10,3			1,6	
39	12 B-1	W 114303 M6		19,05	¾ "	18	27,7	35,2	M6		19,05	11,9			1,8	
39	16 B-1 SS	W 115948M6		25,4	1 "	25,4	36,8	45,8	M6		25	19			3,1	

Further designs on request!

Special Attachments

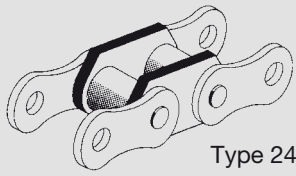

Type 24

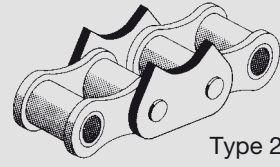
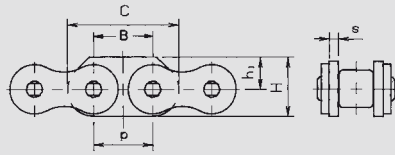

Type 29

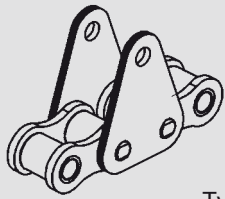
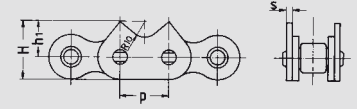

Type 40

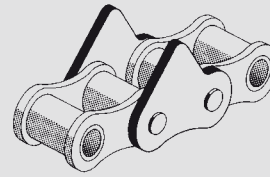
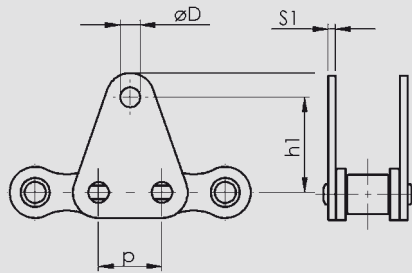

Type 41

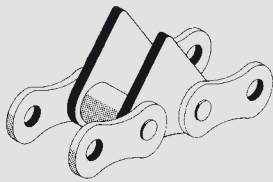
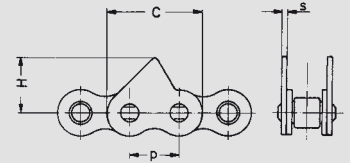

Type 43

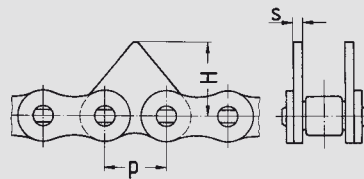

Type of Attachment	Chain description	Name of attachment		Pitch		A	B	C	D	F	G	H	h ₁	h ₂	s ₁	s ₂
		outer	inner	mm	inch	Distance from fixing hole to middle of chain	Width to the middle of chain	Width of the attachment	Diameter of fixing hole	Length of attachment protrusion	Space between the holes	Height of the attachment	Height of fixing hole, exterior	Height of fixing hole, interior	Thickness of material, outer	Thickness of material, inner
24	24 B-1	M 701		38,1	1 ¼ "		38,1	72,9				38,8	21,1		6	
29	24 A-1	M 614		38,1	1 ¼ "							37,5			4	
40	08 B-1	M 240		12,7	½ "				3,9			17	12		3,5	
41	12 B-1	M 410	M 413	19,05	¾ "			35,5				21			1,8	1,8
41	12 B-1		M 413	19,05	¾ "			35,5				21				1,8
43	16 B-X	M 512*		25,4	1 "							30,6			6	
43	16 B-1		M 529	25,4	1 "							30,8				3,75
43	24 A-1	M 624		38,1	1 ¼ "							40,7			8	

* Intermediate plate for Multiple Strand Roller Chains.

Further designs on request!

Special Attachments

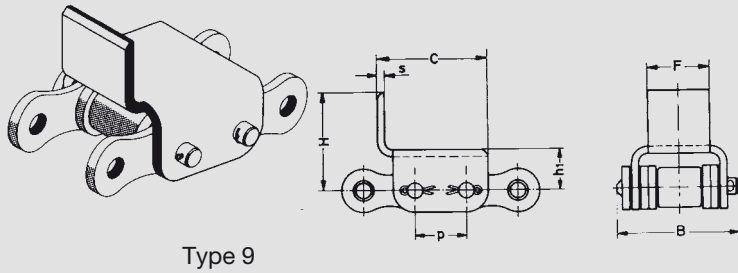

Type 9

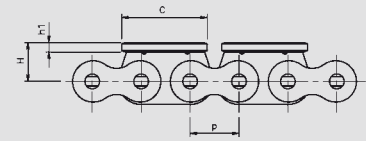

Type 67

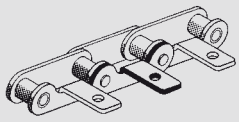
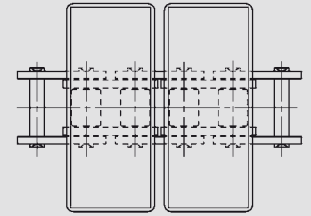

Type 19

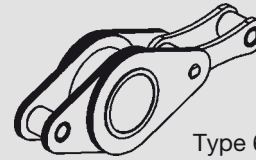
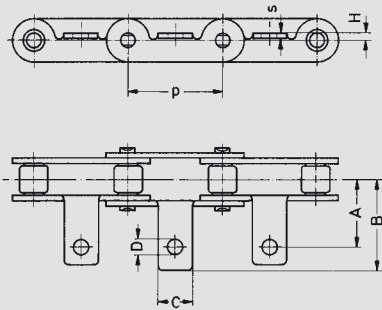

Type 68

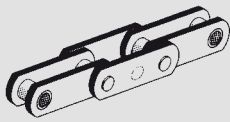
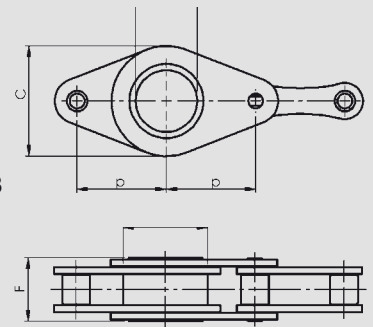

Type 31

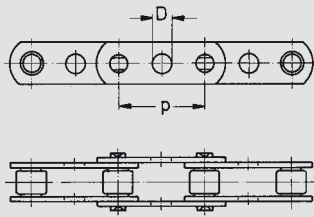

Type of Attachment	Chain description	Name of attachment		Pitch		A	B	C	D	F	G	H	h ₁	h ₂	s ₁	s ₂
		outer	inner	mm	inch	Distance from fixing hole to middle of chain	Width to the middle of chain	Width of the attachment	Diameter of fixing hole	Length of attachment protrusion	Space between the holes	Height of the attachment	Height of fixing hole, exterior	Height of fixing hole, interior	Thickness of material, outer	Thickness of material, inner
9	20-1 (old: Re 487)	Z187		20	0,787		45,6	42		24		37,5	16		3	
19	210 A	W 584	W 585	31,75	1 ¼"	23	30,95	11	5,2			3				2
31	212 A H GL (old: C 2060 H)	L256		38,1	1 ½"				6,45						3,1	
31	216 A H GL (old: C 2080 H)	L270		50,8	2"				7,8						4	
67	20-1*		M 485	20	0,787			32				14,6	2,6			3,1
67	20-1*		M 487	20	0,787			32				14,6	2,6			3,1
68	216 B H	BU 226		50,8	2"			63	35 D ¹²	36	48				3,9	3,9

* available as Bushing Chain or Roller Chain.

Further designs on request!

We specialise in these...

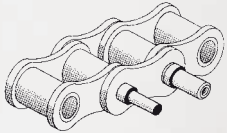

Type 44

Our Type 44 Attachment covers a range of special extended pins - examples are shown below. Whilst we do have a specific range available which could satisfy your needs, please contact us with details of your individual requirements.



... Have a word with us!

**Germany
Netherlands
Switzerland
Austria**

**Zentrale
Rexnord Kette GmbH**
Industriestraße 1
D-57518 Betzdorf
Phone: +49 2741 284-0
Fax: +49 2741 284-250
E-mail: rexinfo@rexnord.com

**Rexnord Kette GmbH
Vertriebsbüro Süd-Ost**
Edelweißring 83
D-86343 Königsbrunn
Phone: +49 8231 908-20
Fax: +49 8231 908-21
Mobil: +49 171 1213374
E-mail: oswald.wirth@rexnord.com

**Rexnord Kette GmbH
Vertriebsbüro Nord-Ost**
Schwimmbadstr. 5
D-57648 Unnau
Phone: +49 2661 916025
Fax: +49 2661 916026
Mobil: +49 171 4266308
E-mail: guenter.krack@rexnord.com

**Rexnord Kette GmbH
Vertriebsbüro Nord-West/NL**
Schulweg 2
D-57582 Nauroth
Phone: +49 2747 913088
Fax: +49 2747 913090
Mobil: +49 171 4435145
E-mail: torsten.arend@rexnord.com

**Rexnord Kette GmbH
Vertriebsbüro Süd-West/CH**
Reebweg 17
70565 Stuttgart
Phone: +49 711 7456 184
Fax: +49 711 7456 183
Mobil: +49 171 5 72 58 57
E-mail: wolfgang.stich@rexnord.com

**Austria & Eastern Europe
Rexnord Kette GmbH**
Siebenbürgengasse 15
A-9073 Viktring- Klagenfurt
Phone: +43 463 292-669
Fax: +43 463 292-669
Mobil: +43 664 4590708
E-mail: hans.dengg@rexnord.com

Europe

**Great Britain, Redditch
Rexnord Office 32**
Imex Spaces Business Park
Oxleasow Road
East Moons Moat
B98 ORE, United Kingdom
Phone: +44 (1527) 830473
Fax: +44 (1527) 830501
E-mail: derek.mack@rexnord.com

**Denmark, Holte
Rexnord Kette**
Skovlytoften 26
DK-2840 Holte
Phone: +45 (45) 469702
Fax: +45 (45) 469701
E-mail: erik.nielsen@rexnord.dk

**Finland, Joensuu
Rexnord**
Länsikatu 15
FI-80110 Joensuu
Phone: +358 400 670 787
Fax: +358 132 637 154
E-mail: timo.sistonen@rexnord.com

**Spain/Portugal, Madrid
Rexnord**
c/ ALAVA, 11, Bajo D
28017 Madrid, Spain
Phone: +34-91-233-5653
Fax: +34-91-233-5653
Mobil: +34-690-79-318
E-mail: claudio.lopresto@rexnord.com

**France, Colombes
Rexnord France, sarl.**
Europarc
142-176 Av de Stalingrad, Bât 5
F - 92700 Colombes
Phone: +33 147 601 960
Fax: +33 147 812 929
E-mail: gilles.pladeau@rexnord.com

**Italy, Milano
Rexnord**
Via Cassanese, 224
Centro Direzionale Milano Oltre
Piazza Tintoretto Piano 1
I-20090 Segrate (MI)
Phone: +39 02 2699271
Mobil: +39 347 7758817
E-mail: massimo.camisasca@rexnord.com

World

**Australia, Picton
Rexnord Australia Pty. Ltd.**
25 Henry Street
Picton NSW 2571
P.O. Box 620
Phone: +61-2-4677-3811
Fax: +61-2-4677-3812

**Brazil, Sao Leopoldo
Rexnord Correntes Ltda.**
Rua Christopher Levalley, 187
93037-730 Sao Leopoldo - RS
Phone: +55-51-579-8022
Fax: +55-51-579-8029

**Canada, Toronto
Rexnord Canada**
81 Maybrook Drive
Scarborough, Ontario M1V 3Z2
Phone: +1 416-297-6868
Fax: +1 416-297-6873

**Singapore
Rexnord International, Inc.**
One Sims Lane
Singapore 387 355
Phone: +65-6338-5622
Fax: +65-6338-5422

**Latin America, Miami
Rexnord International, Inc.**
7200 N.W. 19th Street
Suit 202
Miami, Florida 33126
Phone: +1-305-592-4367
Fax: +1-305-592-5384

**United States, Milwaukee
Rexnord Industries, Inc.**
4701 W. Greenfield Avenue
Milwaukee, WI 53214
Phone: +1-414-643-3000
Fax: +1-414-643-3078



Rexnord Kette GmbH

Postfach 120

57501 Betzdorf

Industriestraße 1

57518 Betzdorf

Tel. +49 2741 284 - 0

Fax. +49 2741 284 - 253 / 362 / 368

email: rexinfo@rexnord.com

www.rexnord.eu